

# LS-LEDS818 Series Solar Integrated Bollard

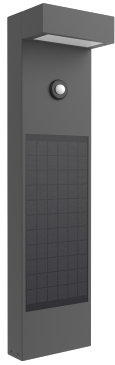

Elegant design equipped with integrated solar photovoltaic panels, glare-free concealed optics in a refined and chic solution to complement contemporary urban spaces. The premium integrated solar bollard provides an economical, aesthetic, comfortable illumination for the creation of ambiance with 100% energy saving. Utilising high-efficiency solar cells, the light fixture charges 360° with no onsite orientation, ensuring optimal lighting throughout the year.

Integrate solar photovoltaic technology into lighting systems, large flat solar panel is no longer needed. This seamlessly integrates the technology aesthetically without compromising the efficiency, adding value to both designers and end users. It minimises the maintenance burden of dirt or snow built up on the photovoltaic surfaces, requiring less frequent and easier cleaning. The vertical wrap around panels receive light more evenly and efficiently from the sun and sky during daylight hours, even in darker climates and seasons.

The luminaire reaches 3 days operation time with additional benefits include built-in motion sensor and programmable time dimming offer longer discharge time and optimum performance. This luminaire also complies with the dark sky requirement with low upward lighting pollution.

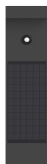

Integrated vertical PV provides aesthetic view, avoids snow or sand collection

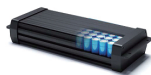

Using Iron Phosphate Lithium LiFePO4 battery, superior safety. Built-in protection for over-charge, over discharge, over current and over temperature



Unit supplied with ground fixing kit

## Product information

Durable with rated life span L70>50,000 hours / Mono-Si solar panel / LiFePO4 battery / Electronic protection battery management system / No UV or IR emissions / CE, UKCA & RoHS international standards / Environmentally friendly & part recyclable: no mercury or other hazardous materials used / Heavy duty die-cast aluminium housing & polycarbonate lens / Complies with EN60598

Code	Solar Module †	Lumen Output Maximum	LiFePO4 Battery	Control Mode	Discharge Time* Maximum	Nett Weight
LS-LEDS818A	22W/18V*2	1,120lm	103WH/3.2V 32Ah	D2D / STD / TC	> 3 days	11.9kg
LS-LEDS818T	22W/18V*2	1,120lm	103WH/3.2V 32Ah	D2D / STD / TC	> 3 days	13.0kg

† Calculations are done with the 3 hours of Peak Sun Hour

\* Calculations are done with 12 hours of operation per day, detection of movement is 5 times per hour  
Autonomy and Operation time calculations are only indicative and will depend on several variable factors

## Dimensions and mounting

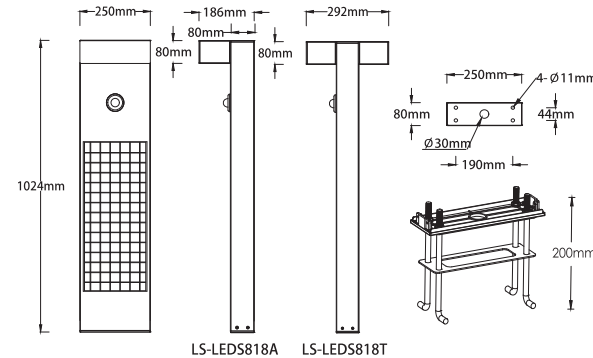

## Technical Specification

Beam Angle: TypeIII / TypeV  
Luminous Efficacy: 160lm/W  
Color Rendering Index: ≥80Ra  
LED Type: LM80 3030LEDs  
Solar Panel: Mono-si (25 years of anticipated lifespan)  
Battery: LiFePO4 (8 years of anticipated lifespan)  
Solar Charge Controller: MPPT  
System Design: 3.2 VDC  
Charging Time: 4-5 hours  
Control Mode: D2D (Dusk to Dawn) / STD (Step Dimming with Motion Sensor Override / TC (Time Control)  
Operating Hours: >3 days  
Color Temperature: Neutral White 4000K  
(Others available on request)

## Applications:



## Control Mode Program

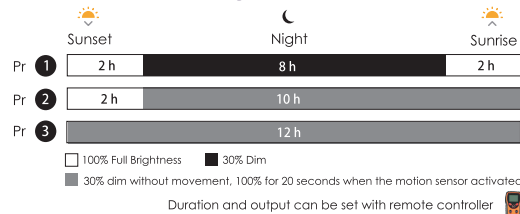

## Photometric distribution

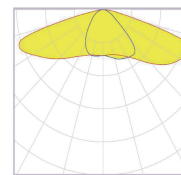

Type III

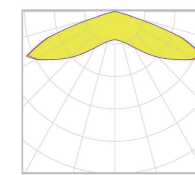

Type v

## Benefits -

- Ideal for use in the remote areas where mains power is not available

## Key Features -

- Truly green lighting solution and 100% energy savings
- Long anticipated lifespan of Mono-Si solar panel and LiFePO4 battery
- Robust design for maintained performance over time
- Quick and easy installation without making electrical connections
- High performance lighting with optimised light distributions designed for exterior areas